

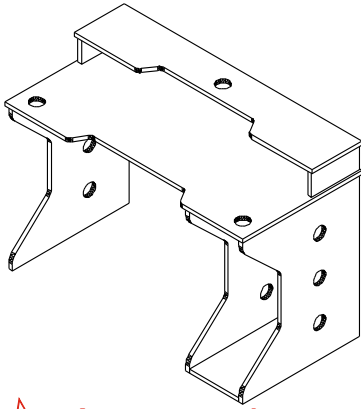









# POWER GAMING TABLE

## ASSEMBLY INSTRUCTION

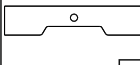
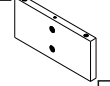

<b>A'</b>  MINIFIX 20	<b>B'</b>  CONNECTING BOLT 20	<b>C'</b>  DOWEL 26	<b>D'</b>  Spiked Poligrif 6	<b>E'</b>  DUCT PLASTIC 12	<b>G'</b>  4 x 30 SCREW 2
<b>H'</b>  HANGER APPARATUS 1					

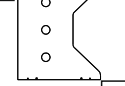
<b>A</b>  TOP TABLE 1	<b>B</b>  INTERMEDIATE TABLE 3	<b>C</b>  TABLE 1	<b>D</b>  RIGHT FEET 1
---	---	--	---

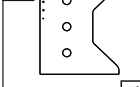
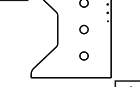
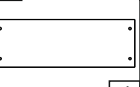
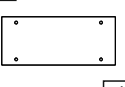
<b>E</b>  MIDDLE FEET 1	<b>F</b>  LEFT FOOT 1	<b>G</b>  FRONT CURTAIN 1	<b>H</b>  DOWN TABLE 1
---	--	--	---

### ★ Attention

- Do not start assembly without being sure that all the parts are complete
- in order not to scratch the parts , place a carton or nylon series on the installation place
- To avoid damages during installation , always work with two peoples
- Keep your children away to avoid tripping and bumping

**1**

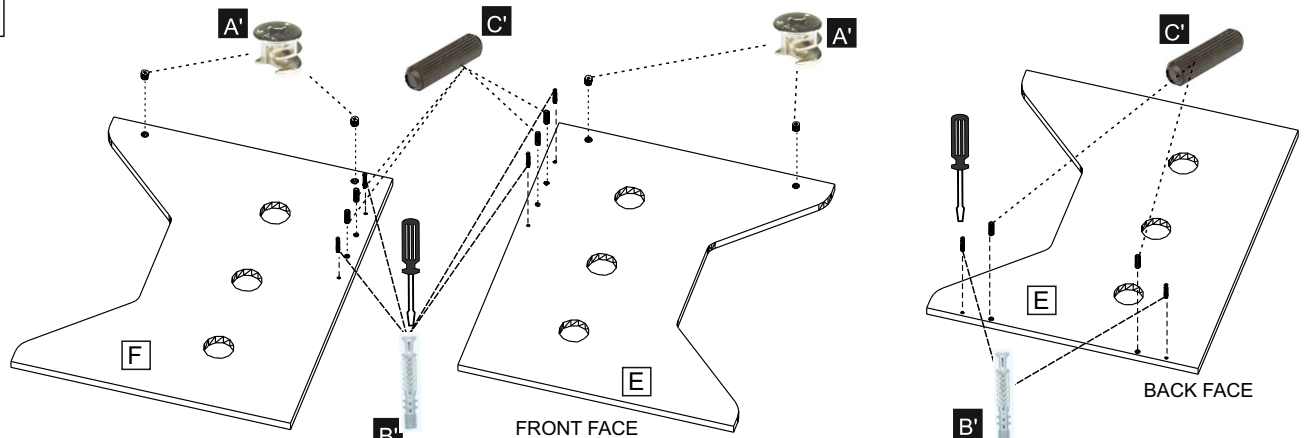

**2**

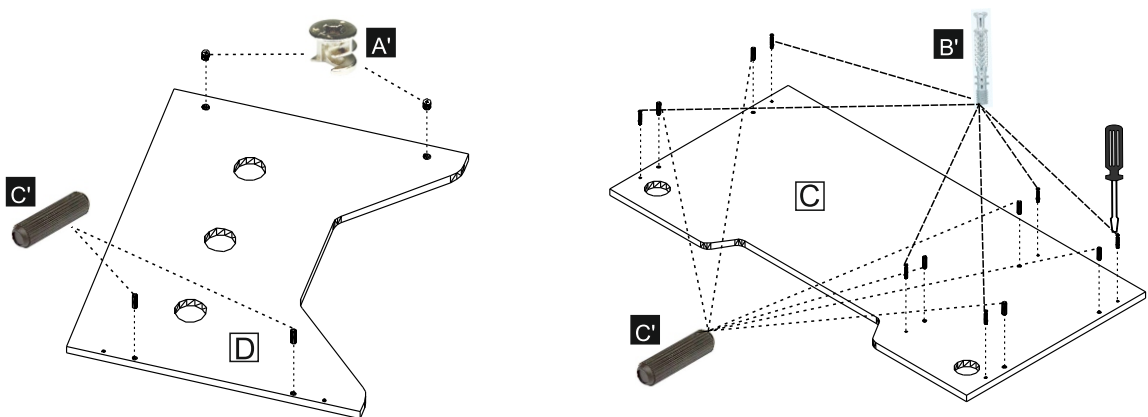

**3**

