







MILENYUM GAMING TABLE ASSEMBLY GUIDE

ASSEMBLY MATERIALS

A'  MINIFIKS HEAD 8	B'  MINIFIX SHAFT 8	C'  DOWEL 8	D'  NAIL PLASTIC 4	E'  DUCT PLASTIC 2
---	---	---	--	--

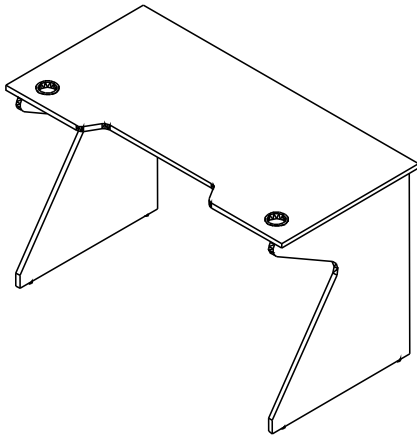

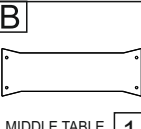
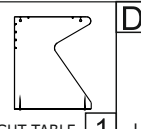
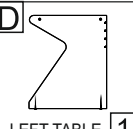
A  TOP TABLE 1	B  MIDDLE TABLE 1	C  RIGHT TABLE 1	D  LEFT TABLE 1
--	---	---	---

- Do not start assembly without being sure that all the parts are complete
- ★ in order not to scratch the parts , place a carton or nylon series on the installation place
- To avoid damages during installation , always work with two peoples
- Keep your children away to avoid tripping and bumping

1

Place the dowel with the help of the core.

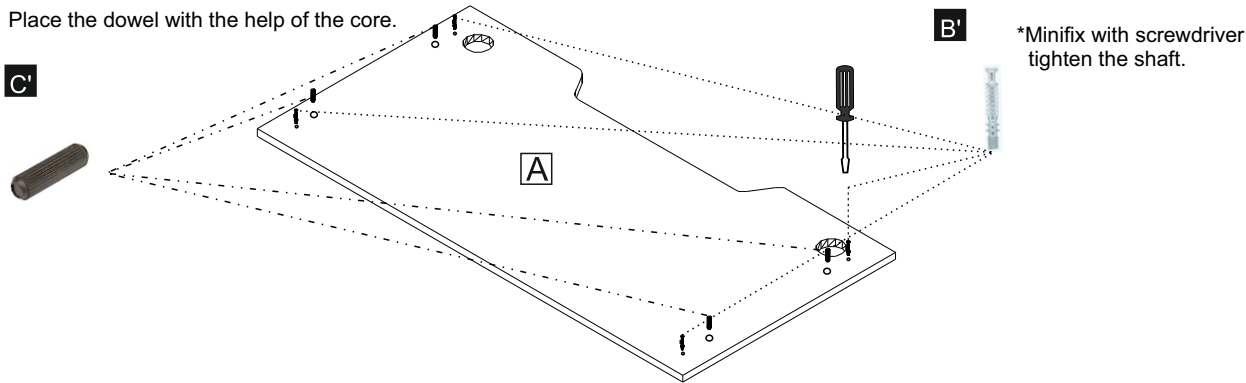

2

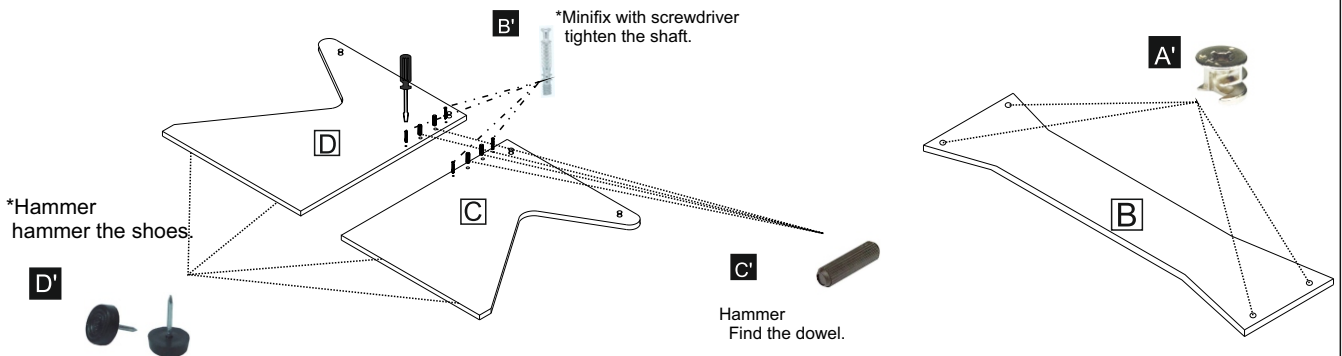

3

